

# PESD1LVDS

ESD protection for in-vehicle ultra high-speed interfaces

Rev. 1 — 10 October 2011

Product data sheet

## 1. Product profile

### 1.1 General description

The device is designed to protect in-vehicle ultra high-speed interfaces in automotive applications, such as Low-Voltage Differential Signaling (LVDS), High-Definition Multimedia Interface (HDMI) and DisplayPort interfaces against ElectroStatic Discharge (ESD).

The device is housed in an ultra small SOT1165-1 (XSON10) Surface-Mounted Design (SMD) plastic package.

### 1.2 Features and benefits

- System ESD protection for LVDS, HDMI and DisplayPort interfaces
- Line capacitance of only 0.6 pF with  $\leq 0.05$  pF matching capacitance between signal pairs
- Ultra small XSON10 package with design-friendly 'pass-thru' signal routing
- AEC-Q101 qualified

### 1.3 Applications

The devices are designed for high-speed receiver and transmitter port protection:

- Automotive A/V monitors, displays and cameras

### 1.4 Quick reference data

Table 1. Quick reference data

Symbol	Parameter	Conditions	Min	Typ	Max	Unit
$V_{RWM}$	reverse standoff voltage		-	-	5.5	V
$C_{ch}$	channel capacitance	$f = 1$ MHz; $V_{bias} = 2.5$ V	[1] -	0.6	-	pF

[1] This parameter is guaranteed by design.



## 2. Pinning information

**Table 2. Pinning**

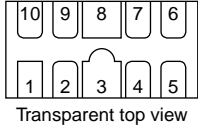
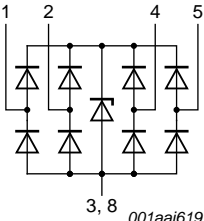
Pin	Symbol	Description	Simplified outline	Graphic symbol
1	CH1-	negative channel 1 ESD protection	 <p>Transparent top view</p> <p><b>XSON10</b></p>	 <p>001aai619</p>
2	CH1+	positive channel 1 ESD protection		
3	GND	ground		
4	CH2-	negative channel 2 ESD protection		
5	CH2+	positive channel 2 ESD protection		
6	n.c.	not connected		
7	n.c.	not connected		
8	GND	ground		
9	n.c.	not connected		
10	n.c.	not connected		

## 3. Ordering information

**Table 3. Ordering information**

Type number	Package		
	Name	Description	Version
PESD1LVDS	XSON10	plastic extremely thin small outline package; no leads; 10 terminals; body 1 × 2.5 × 0.5 mm	SOT1165-1

## 4. Limiting values

**Table 4. Limiting values**

In accordance with the Absolute Maximum Rating System (IEC 60134).

Symbol	Parameter	Conditions	Min	Max	Unit
$T_{stg}$	storage temperature		-55	+125	°C
$T_{amb}$	ambient temperature		-40	+85	°C

**Table 5. ESD maximum ratings**

$T_{amb} = 25$  °C unless otherwise specified.

Symbol	Parameter	Conditions	Min	Max	Unit
$V_{ESD}$	electrostatic discharge voltage	IEC 61000-4-2 (contact discharge)	[1][2] -	±8	kV

[1] Device stressed with ten non-repetitive ESD pulses.

[2] All pins to ground.

**Table 6. ESD standards compliance**

Standard	Conditions
IEC 61000-4-2; level 4 (ESD)	> 8 kV (contact)
MIL-STD-883; class 3B (human body model)	> 8 kV

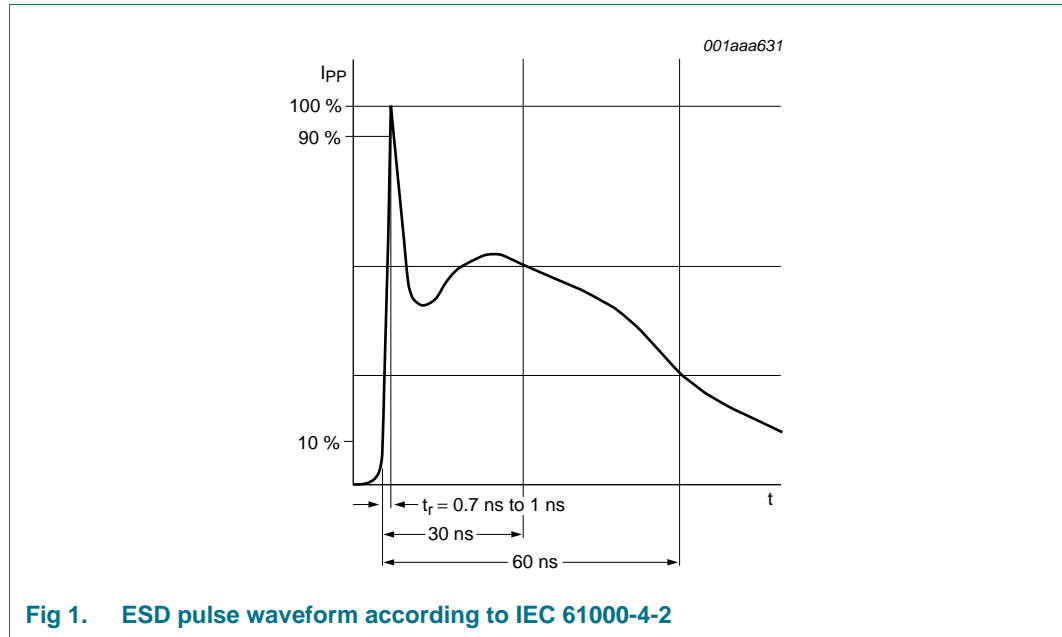

**Fig 1. ESD pulse waveform according to IEC 61000-4-2**

## 5. Characteristics

**Table 7. Characteristics**

$T_{amb} = 25\text{ }^{\circ}\text{C}$  unless otherwise specified.

Symbol	Parameter	Conditions	Min	Typ	Max	Unit
$V_{RWM}$	reverse standoff voltage		-	-	5.5	V
$I_{RM}$	reverse leakage current	per channel; $V = 3.0\text{ V}$	-	-	1	$\mu\text{A}$
$V_{BR}$	breakdown voltage	$I = 1\text{ mA}$	6	-	9	V
$V_F$	forward voltage		-	0.7	-	V
$C_{(I/O-GND)}$	input/output to ground capacitance	$f = 1\text{ MHz};$ $V_{bias} = 2.5\text{ V}$	[1]	-	0.6	pF
$\Delta C_{(I/O-GND)}$	input/output to ground capacitance variation	$f = 1\text{ MHz};$ $V_{bias} = 2.5\text{ V}$	[1]	-	0.05	pF
$C_{ch(mutual)}$	mutual channel capacitance	$f = 1\text{ MHz};$ $V_{bias} = 2.5\text{ V}$	[1][2]	-	0.07	pF

[1] This parameter is guaranteed by design.

[2] Between signal pin and pin n.c.

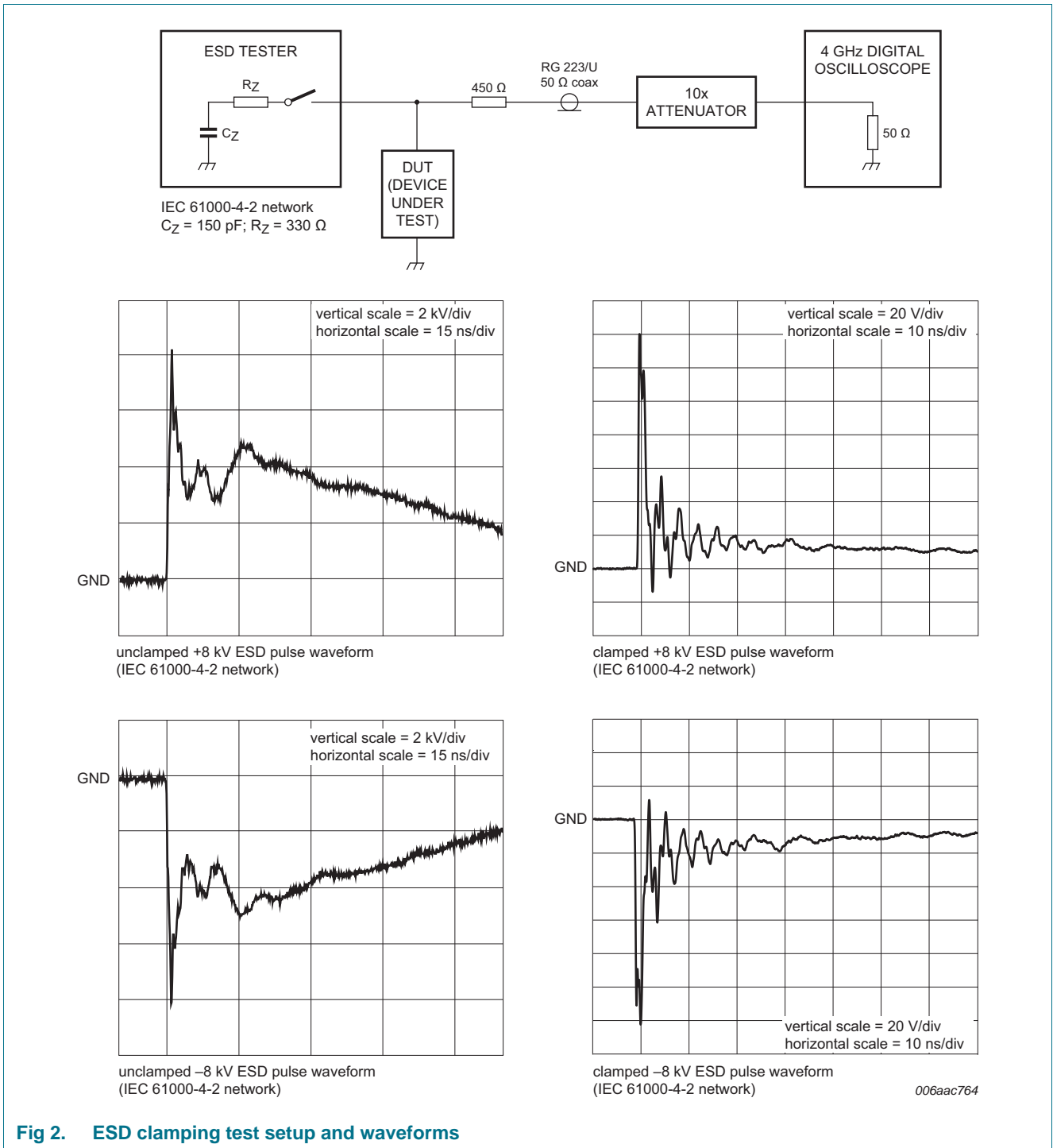

Fig 2. ESD clamping test setup and waveforms

## 6. Application information

The devices are designed to provide high-level ESD protection for high-speed serial data buses such as LVDS, HDMI and DisplayPort data lines.

When designing the Printed-Circuit Board (PCB), careful consideration should be given to impedance matching, and signal coupling.

Basic application diagrams for the ESD protection of an HDMI interface are shown in [Figure 3](#).

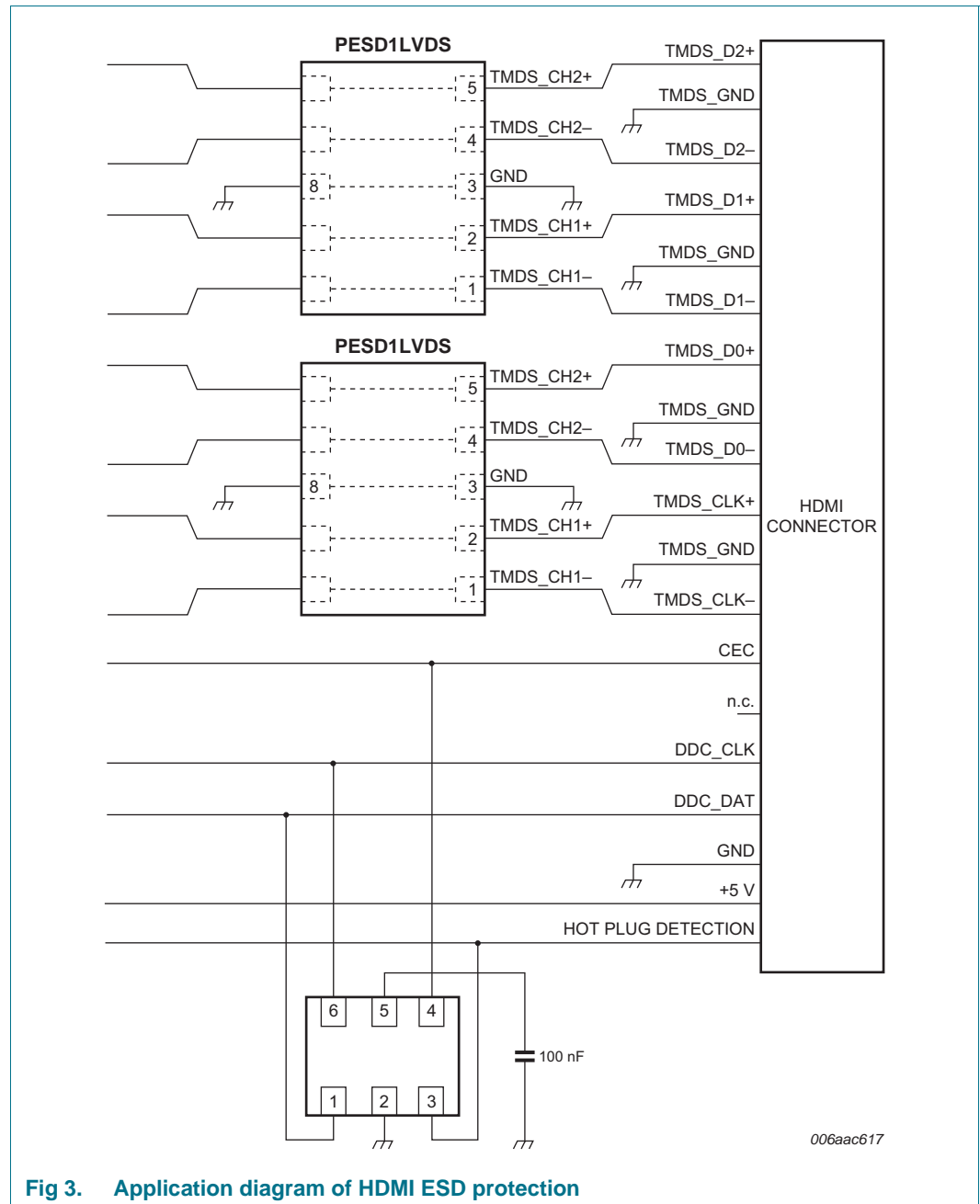

Fig 3. Application diagram of HDMI ESD protection

## 7. Test information

---

### 7.1 Quality information

This product has been qualified in accordance with the Automotive Electronics Council (AEC) standard *Q101 - Stress test qualification for discrete semiconductors*, and is suitable for use in automotive applications.

## 8. Package outline

**XSON10:** plastic, extremely thin small outline package; no leads;  
**10 terminals;** body 1 x 2.5 x 0.5 mm

SOT1165-1

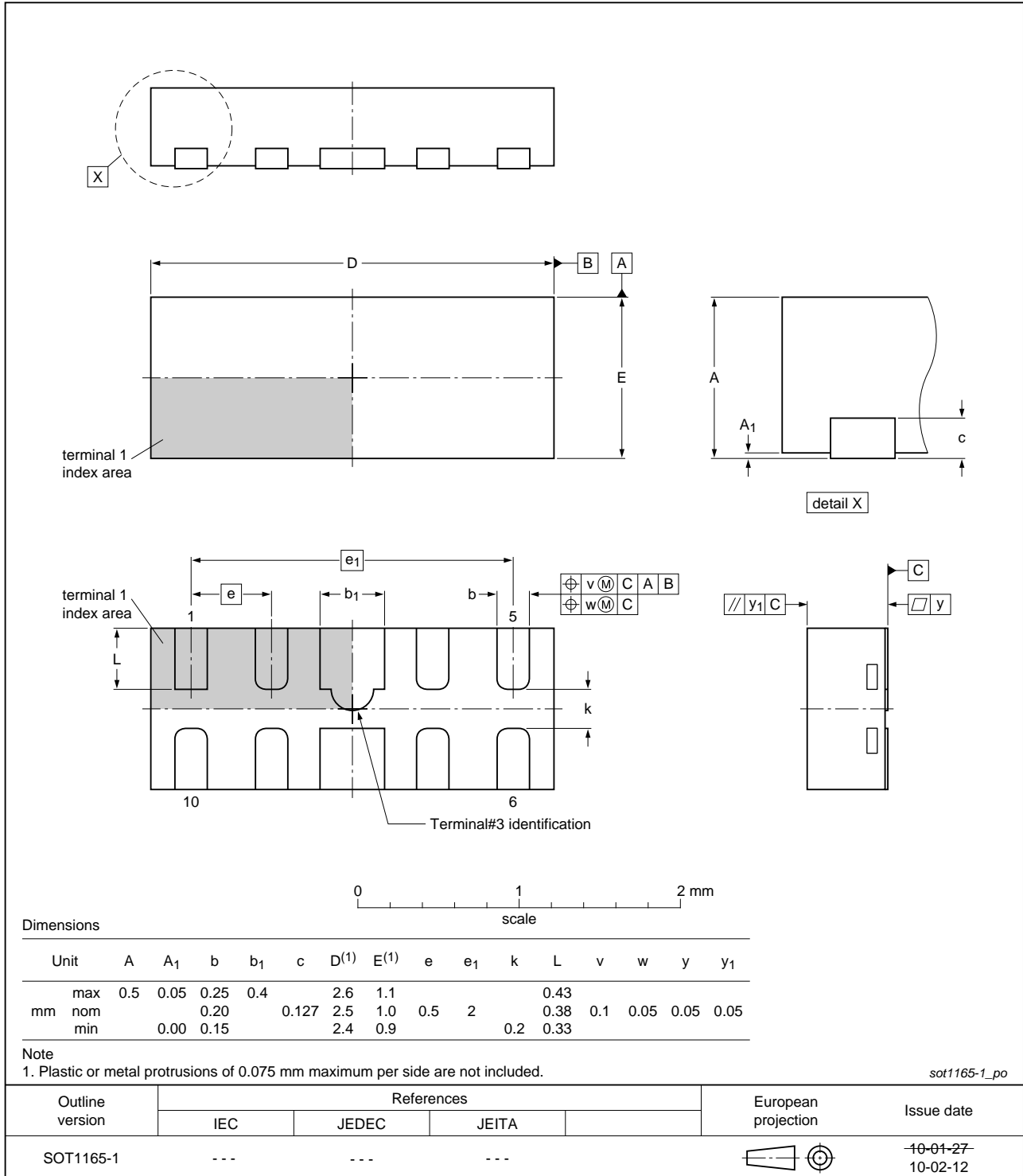
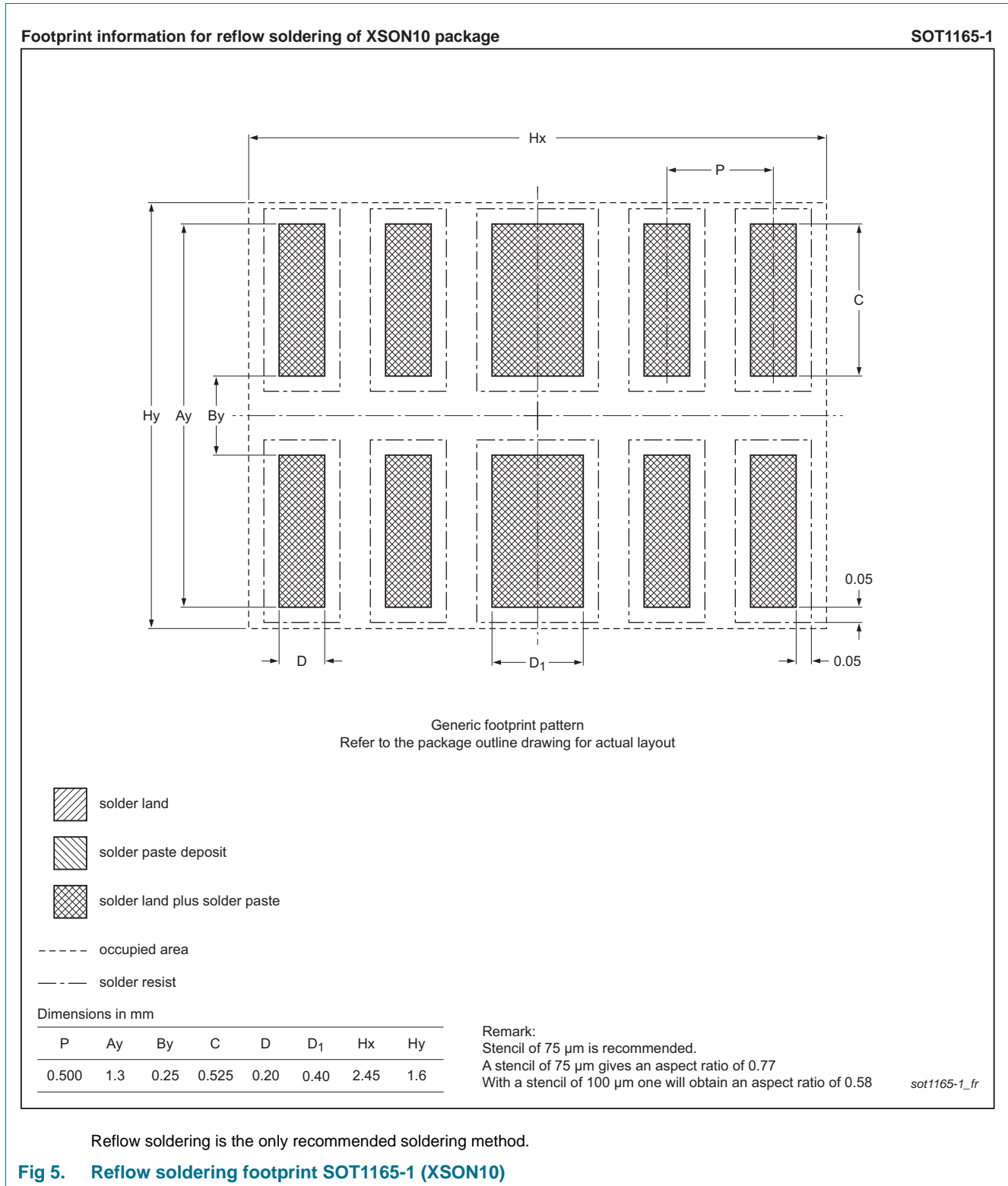

Fig 4. Package outline SOT1165-1 (XSON10)

## 9. Soldering





## 10. Revision history

---

**Table 8.** Revision history

Document ID	Release date	Data sheet status	Change notice	Supersedes
PESD1LVDS v.1	20111010	Product data sheet	-	-

## 11. Legal information

### 11.1 Data sheet status

Document status <sup>[1][2]</sup>	Product status <sup>[3]</sup>	Definition
Objective [short] data sheet	Development	This document contains data from the objective specification for product development.
Preliminary [short] data sheet	Qualification	This document contains data from the preliminary specification.
Product [short] data sheet	Production	This document contains the product specification.

[1] Please consult the most recently issued document before initiating or completing a design.

[2] The term 'short data sheet' is explained in section "Definitions".

[3] The product status of device(s) described in this document may have changed since this document was published and may differ in case of multiple devices. The latest product status information is available on the Internet at URL <http://www.nxp.com>.

### 11.2 Definitions

**Draft** — The document is a draft version only. The content is still under internal review and subject to formal approval, which may result in modifications or additions. NXP Semiconductors does not give any representations or warranties as to the accuracy or completeness of information included herein and shall have no liability for the consequences of use of such information.

**Short data sheet** — A short data sheet is an extract from a full data sheet with the same product type number(s) and title. A short data sheet is intended for quick reference only and should not be relied upon to contain detailed and full information. For detailed and full information see the relevant full data sheet, which is available on request via the local NXP Semiconductors sales office. In case of any inconsistency or conflict with the short data sheet, the full data sheet shall prevail.

**Product specification** — The information and data provided in a Product data sheet shall define the specification of the product as agreed between NXP Semiconductors and its customer, unless NXP Semiconductors and customer have explicitly agreed otherwise in writing. In no event however, shall an agreement be valid in which the NXP Semiconductors product is deemed to offer functions and qualities beyond those described in the Product data sheet.

### 11.3 Disclaimers

**Limited warranty and liability** — Information in this document is believed to be accurate and reliable. However, NXP Semiconductors does not give any representations or warranties, expressed or implied, as to the accuracy or completeness of such information and shall have no liability for the consequences of use of such information.

In no event shall NXP Semiconductors be liable for any indirect, incidental, punitive, special or consequential damages (including - without limitation - lost profits, lost savings, business interruption, costs related to the removal or replacement of any products or rework charges) whether or not such damages are based on tort (including negligence), warranty, breach of contract or any other legal theory.

Notwithstanding any damages that customer might incur for any reason whatsoever, NXP Semiconductors' aggregate and cumulative liability towards customer for the products described herein shall be limited in accordance with the *Terms and conditions of commercial sale* of NXP Semiconductors.

**Right to make changes** — NXP Semiconductors reserves the right to make changes to information published in this document, including without limitation specifications and product descriptions, at any time and without notice. This document supersedes and replaces all information supplied prior to the publication hereof.

**Suitability for use** — NXP Semiconductors products are not designed, authorized or warranted to be suitable for use in life support, life-critical or safety-critical systems or equipment, nor in applications where failure or

malfunction of an NXP Semiconductors product can reasonably be expected to result in personal injury, death or severe property or environmental damage. NXP Semiconductors accepts no liability for inclusion and/or use of NXP Semiconductors products in such equipment or applications and therefore such inclusion and/or use is at the customer's own risk.

**Applications** — Applications that are described herein for any of these products are for illustrative purposes only. NXP Semiconductors makes no representation or warranty that such applications will be suitable for the specified use without further testing or modification.

Customers are responsible for the design and operation of their applications and products using NXP Semiconductors products, and NXP Semiconductors accepts no liability for any assistance with applications or customer product design. It is customer's sole responsibility to determine whether the NXP Semiconductors product is suitable and fit for the customer's applications and products planned, as well as for the planned application and use of customer's third party customer(s). Customers should provide appropriate design and operating safeguards to minimize the risks associated with their applications and products.

NXP Semiconductors does not accept any liability related to any default, damage, costs or problem which is based on any weakness or default in the customer's applications or products, or the application or use by customer's third party customer(s). Customer is responsible for doing all necessary testing for the customer's applications and products using NXP Semiconductors products in order to avoid a default of the applications and the products or of the application or use by customer's third party customer(s). NXP does not accept any liability in this respect.

**Limiting values** — Stress above one or more limiting values (as defined in the Absolute Maximum Ratings System of IEC 60134) will cause permanent damage to the device. Limiting values are stress ratings only and (proper) operation of the device at these or any other conditions above those given in the Recommended operating conditions section (if present) or the Characteristics sections of this document is not warranted. Constant or repeated exposure to limiting values will permanently and irreversibly affect the quality and reliability of the device.

**Terms and conditions of commercial sale** — NXP Semiconductors products are sold subject to the general terms and conditions of commercial sale, as published at <http://www.nxp.com/profile/terms>, unless otherwise agreed in a valid written individual agreement. In case an individual agreement is concluded only the terms and conditions of the respective agreement shall apply. NXP Semiconductors hereby expressly objects to applying the customer's general terms and conditions with regard to the purchase of NXP Semiconductors products by customer.

**No offer to sell or license** — Nothing in this document may be interpreted or construed as an offer to sell products that is open for acceptance or the grant, conveyance or implication of any license under any copyrights, patents or other industrial or intellectual property rights.

**Export control** — This document as well as the item(s) described herein may be subject to export control regulations. Export might require a prior authorization from competent authorities.

**Quick reference data** — The Quick reference data is an extract of the product data given in the Limiting values and Characteristics sections of this document, and as such is not complete, exhaustive or legally binding.

## 11.4 Trademarks

Notice: All referenced brands, product names, service names and trademarks are the property of their respective owners.

## 12. Contact information

---

For more information, please visit: <http://www.nxp.com>

For sales office addresses, please send an email to: [salesaddresses@nxp.com](mailto:salesaddresses@nxp.com)

## 13. Contents

---

<b>1</b>	<b>Product profile</b> . . . . .	<b>1</b>
1.1	General description . . . . .	1
1.2	Features and benefits . . . . .	1
1.3	Applications . . . . .	1
1.4	Quick reference data . . . . .	1
<b>2</b>	<b>Pinning information</b> . . . . .	<b>2</b>
<b>3</b>	<b>Ordering information</b> . . . . .	<b>2</b>
<b>4</b>	<b>Limiting values</b> . . . . .	<b>2</b>
<b>5</b>	<b>Characteristics</b> . . . . .	<b>3</b>
<b>6</b>	<b>Application information</b> . . . . .	<b>5</b>
<b>7</b>	<b>Test information</b> . . . . .	<b>6</b>
7.1	Quality information . . . . .	6
<b>8</b>	<b>Package outline</b> . . . . .	<b>7</b>
<b>9</b>	<b>Soldering</b> . . . . .	<b>8</b>
<b>10</b>	<b>Revision history</b> . . . . .	<b>9</b>
<b>11</b>	<b>Legal information</b> . . . . .	<b>10</b>
11.1	Data sheet status . . . . .	10
11.2	Definitions . . . . .	10
11.3	Disclaimers . . . . .	10
11.4	Trademarks . . . . .	11
<b>12</b>	<b>Contact information</b> . . . . .	<b>11</b>
<b>13</b>	<b>Contents</b> . . . . .	<b>12</b>

---

Please be aware that important notices concerning this document and the product(s) described herein, have been included in section 'Legal information'.

---

© NXP B.V. 2011.

All rights reserved.

For more information, please visit: <http://www.nxp.com>

For sales office addresses, please send an email to: [salesaddresses@nxp.com](mailto:salesaddresses@nxp.com)

Date of release: 10 October 2011

Document identifier: PESD1LVDS